



## High-power Infrared LED



### Features

- ◆ High luminous efficiency
- ◆ Wide angle: 120 °
- ◆ Maximum operating current: 1 A
- ◆ High thermal conductivity ceramic substrate
- ◆ Low thermal resistance: 9 /W
- ◆ Electrically neutral thermal path
- ◆ RoHS-compliant

### Applications

- ◆ Infrared illumination for cameras
- ◆ Surveillance system
- ◆ Machine vision system
- ◆ CCTV
- ◆ Wireless communication



## Package Dimension

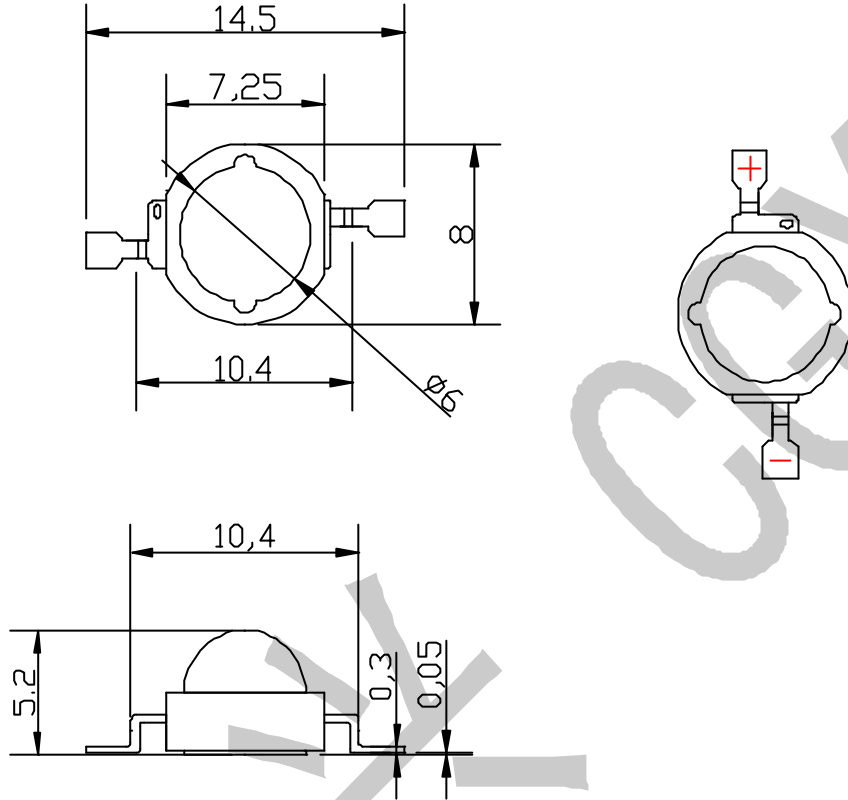

- Notes : 1、 All dimensions are in millimeters.  
2、 Tolerance is  $\pm 0.25$ mm unless otherwise noted.

## Device Selection Guide

Chip Materials	Lens Color
GaAlAs	Water clear



## Absolute Maximum Ratings at Ta=25

Parameter	Symbol	MAX	Unit
Power Dissipation at(or below) 25 free air temperature	$P_d$	1500	mW
Peak Forward Current (1/10 Duty Cycle,0.1ms Pulse Width)	$I_{FP}$	1500	mA
Continuous Forward Current	$I_F$	1000	mA
LED Junction Temp	$T_j$	115	
Reverse Voltage	$V_R$	5	V
Operating Temperature Range	$T_{opr}$	-40 to +85	
Storage Temperature Range	$T_{stg}$	-40 to +100	
Reflow soldering temperature	$T_{sol}$	225 for 10 seconds	

## Electrical Optical Characteristics at Ta=25

Parameter	Symbol	Min	Typ	Max	Uni	Test Condition
Radiated Flux	$P_o$	200	400	----	Mw	$I_F=1000mA$
Viewing Angle	$2_{1/2}$	----	120	----	Deg	
Peak Emission Wavelength	$\lambda_p$	----	940	----	nm	$I_F=1000mA$
Spectral Line Half-Width		----	50	----	nm	$I_F=1000mA$
Forward Voltage	$V_F$	1.4	1.6	2.0	V	$I_F=1000mA$
Reverse Current	$I_R$	----	----	10	$\mu A$	$V_R=5V$



## Typical Electro-Optical Characteristics Curve

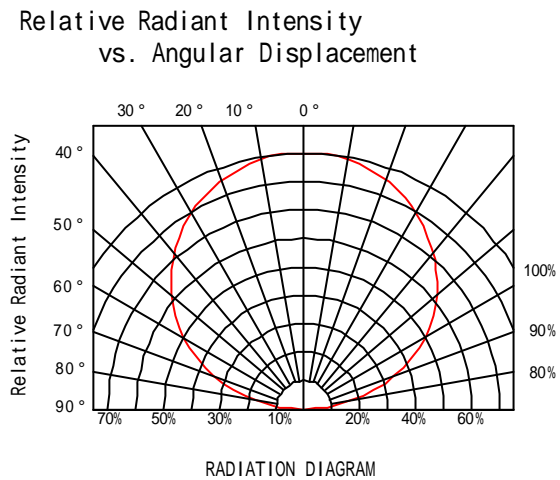
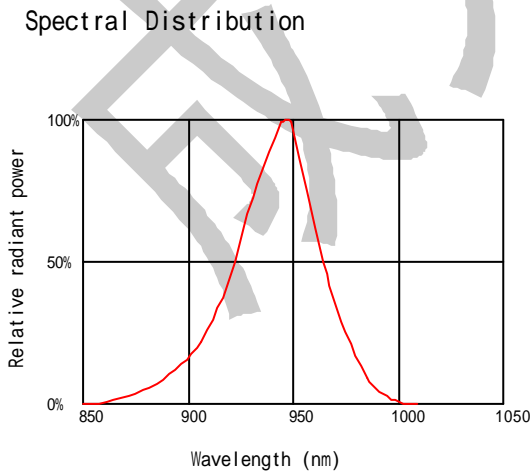
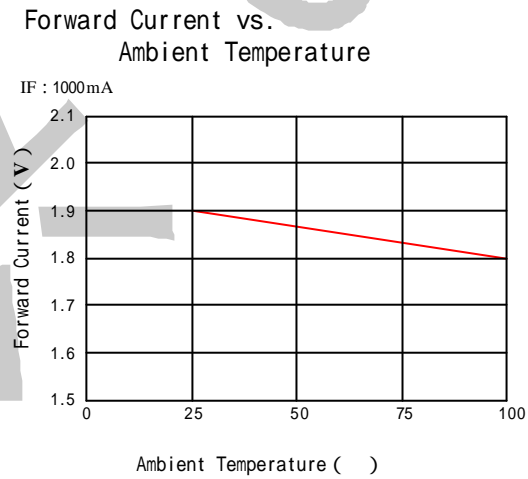
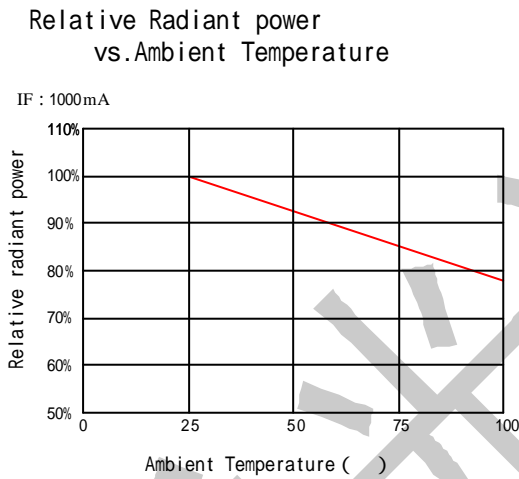
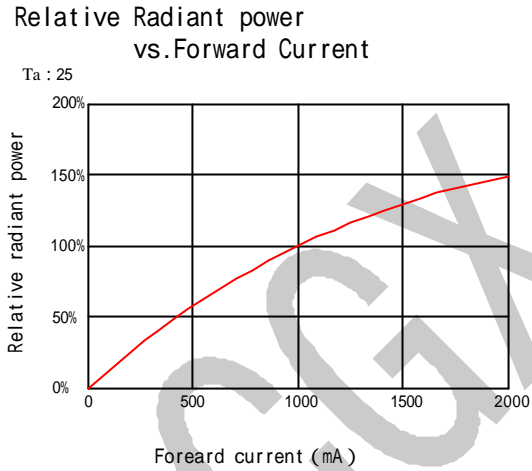
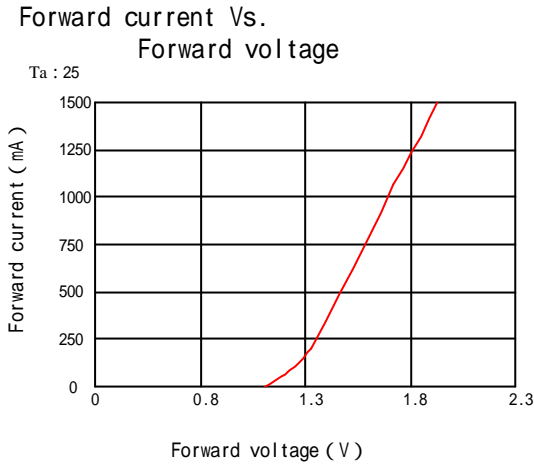



## Reliability test items and test conditions

The reliability of products shall be satisfied with items listed below.

Confidence level : 90%

LTPD (group of permitted defect rate): 10%

No.	Item	Test Conditions	Test Hours/ Cycles	Sample Sizes	Ac/Re	Reference Standard
1	REFLOW Soldering	Temp. : 225 ±5	5secs	22PCS	0/1	JEITA ED-4701 300 302
2	Temperature Cycle	H : +100 15min ~ 5 min L : -40 15min	100Cycles	22PCS	0/1	JEITA ED-4701 100 305
3	Thermal Shock	H : +100 5min ~ 10 sec L : -10 5min	100Cycles	22PCS	0/1	MIL-STD-202G
4	High Temperature Storage	Temp. : 100	1000Hrs	22PCS	0/1	JEITA ED-4701 200 201
5	Low Temperature Storage	Temp. : -40	1000Hrs	22PCS	0/1	JEITA ED-4701 200 202
6	DC Operating Life	IF =1000 mA	1000Hrs	22PCS	0/1	Tested with CGX standard
7	High Temperature/ High Humidity	85 °C /RH85%	1000Hrs	22PCS	0/1	JEITA ED-4701 100 103

Notes : Failure Judgement Criteria : IR U×2 Ie L×0.8 VF U×1.2

U : Upper Specification Limit L : Lower Specification Limit