

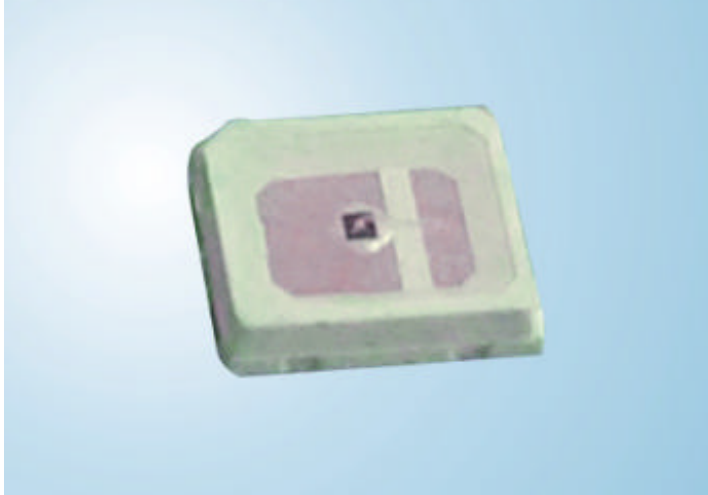

High-power Infrared LED



Features

- ◆ Compact emitter size
- ◆ High luminous efficiency
- ◆ Wide angle: 120 °
- ◆ Maximum operating current: 0.1 A
- ◆ High thermal conductivity ceramic substrate
- ◆ Electrically neutral thermal path
- ◆ RoHS-compliant

Applications

- ◆ Infrared illumination for cameras
- ◆ Surveillance system
- ◆ Machine vision system
- ◆ CCTV
- ◆ Wireless communication



Package Dimension

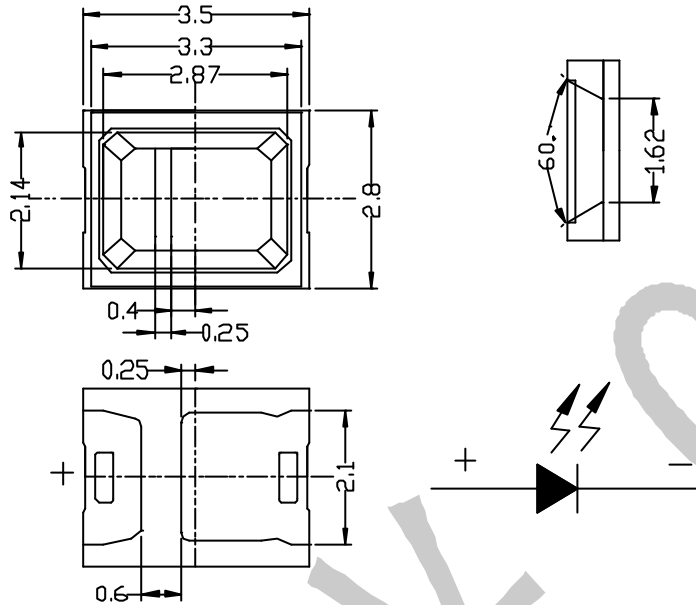

- Notes : 1、 All dimensions are in millimeters.
2、 Tolerance is ± 0.25 mm unless otherwise noted.

Device Selection Guide

Chip Materials	Lens Color
GaAlAs	Water clear



Absolute Maximum Ratings at Ta=25

Parameter	Symbol	MAX	Unit
Power Dissipation at(or below) 25 free air temperature	P_d	300	mW
Peak Forward Current (1/10 Duty Cycle,0.1ms Pulse Width)	I_{FP}	200	mA
Continuous Forward Current	I_F	100	mA
Reverse Voltage	V_R	5	V
Operating Temperature Range	T_{opr}	-40 to +85	
Storage Temperature Range	T_{stg}	-40 to +100	
Reflow soldering temperature	T_{sol}	225 for 10 seconds	

Electrical Optical Characteristics at Ta=25

Parameter	Symbol	Min	Typ	Max	Uni	Test Condition
Radiated Flux	P_o	40	50	----	mw	$I_F=100mA$
Viewing Angle	$2_{1/2}$	----	120	----	Deg	
Peak Emission Wavelength	λ_p	840	855	865	nm	$I_F=100mA$
Spectral Line Half-Width		----	40	----	nm	$I_F=100mA$
Forward Voltage	V_F	1.45	1.55	1.7	V	$I_F=100mA$
Reverse Current	I_R	----	----	10	μA	$V_R=5V$



Typical Electro-Optical Characteristics Curve

Forward current Vs. Forward voltage

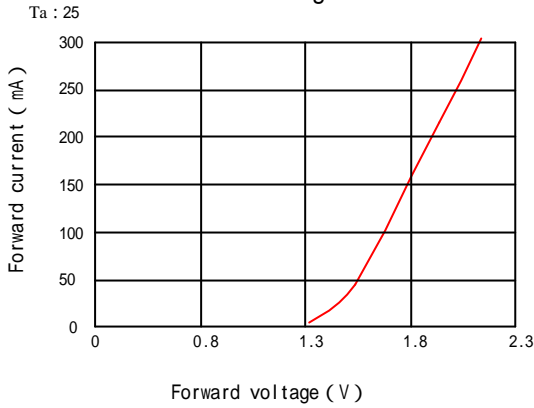

Relative Radiant power vs. Forward Current

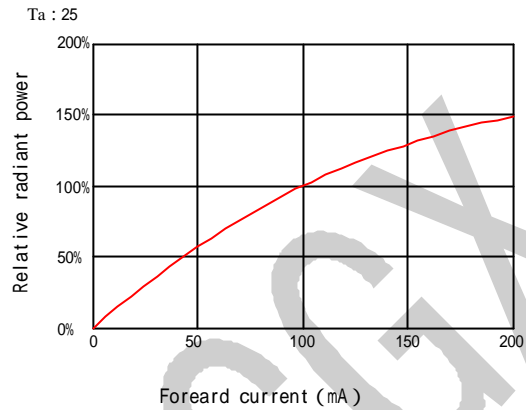

Relative Radiant power vs. Ambient Temperature

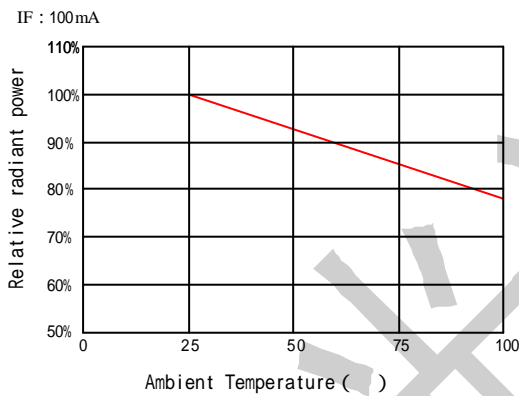

Forward Current vs. Ambient Temperature

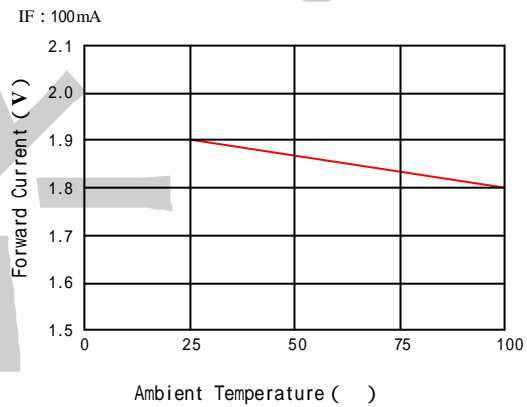

Spectral Distribution

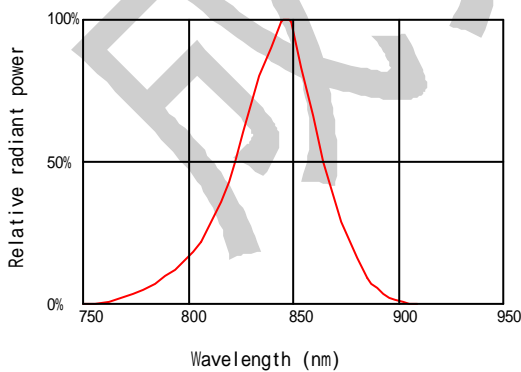

Relative Radiant Intensity vs. Angular Displacement

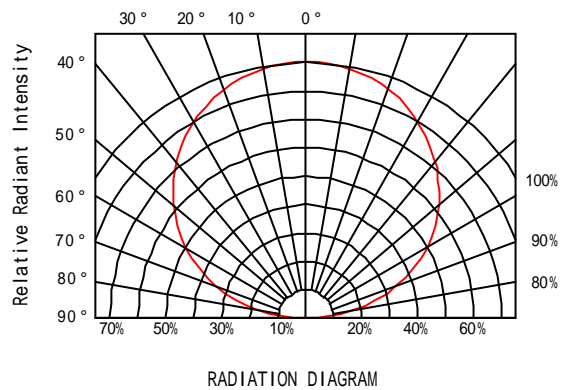

Reliability test items and test conditions



深圳成光兴光电技术股份有限公司

SHENZHEN CGX OPTOELECTRONIC TECHNOLOGY, INC.

CGX-2835IRPC/D14-A

The reliability of products shall be satisfied with items listed below.

Confidence level : 90%

LTPD (group of permitted defect rate): 10%

No.	Item	Test Conditions	Test Hours/ Cycles	Sample Sizes	Ac/Re	Reference Standard
1	REFLOW Soldering	Temp. : 225 ±5	5secs	22PCS	0/1	JEITA ED-4701 300 302
2	Temperature Cycle	H : +100 15min ~ 5 min L : -40 15min	100Cycles	22PCS	0/1	JEITA ED-4701 100 305
3	Thermal Shock	H : +100 5min ~ 10 sec L : -10 5min	100Cycles	22PCS	0/1	MIL-STD-202G
4	High Temperature Storage	Temp. : 100	1000Hrs	22PCS	0/1	JEITA ED-4701 200 201
5	Low Temperature Storage	Temp. : -40	1000Hrs	22PCS	0/1	JEITA ED-4701 200 202
6	DC Operating Life	IF = 100 mA	1000Hrs	22PCS	0/1	Tested with CGX standard
7	High Temperature/ High Humidity	85 /RH85%	1000Hrs	22PCS	0/1	JEITA ED-4701 100 103

Notes : Failure Judgement Criteria : IR U×2 Ie L×0.8 VF U×1.2

U : Upper Specification Limit L : Lower Specification Limit